

DRAWING

CUSTOMER :

accept stamp

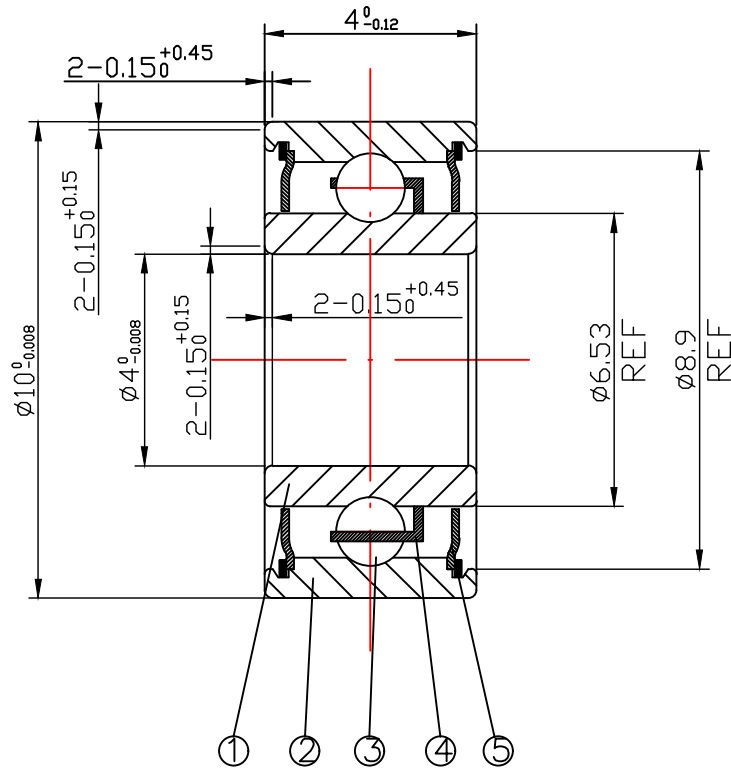

issue stamp

BRAND: ZHY

ALL DIMENSIONS: mm

NOTIONS:

MARKER	PLACES	BEFORE	REVISER	REVISION DATE

NO.	PARTS	MATERIAL	QUANTITY	REMARKS
1	INNER RING	GCr15	1	
2	OUTER RING	GCr15	1	
3	BALLS	GCr15	8- $\phi 1.300$	
4	RETAINER	0Cr19Ni10	1	
5	SHIELD	0Cr19Ni10	2	

LOAD RATING STATIC: COr: 190N

LOAD RATING DYNAMIC: Cr: 490 N

RADIAL PLAY:

C0: 0.002-0.013

TOLERANCES: ABEC-1

CUSTOMER SIZE:

SIZE:

MR104ZZ

DRAWING NO. : QAJ/TR23242

庄宏亿
2023-11-13
陈晶晶

庄宏亿
2023-11-13
陈丹央

庄宏亿
2023-11-13
周宝君

draw

check

approved

DATE:

Nov.13,2023

ZHY NINGBO CHUANG HON YI BEARING CO.,LTD.