

DRAWING

CUSTOMER :

accept stamp

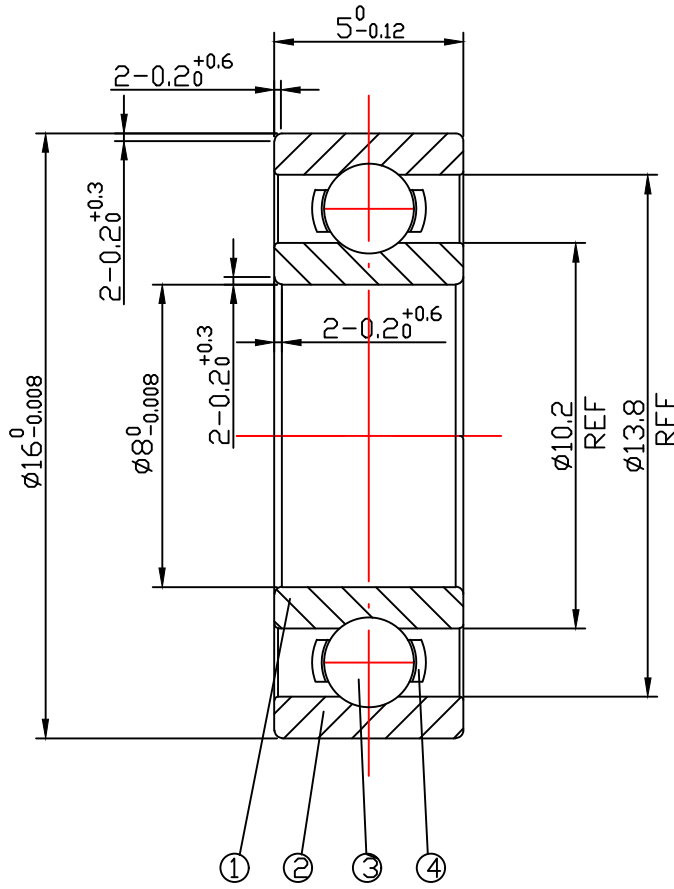

issue stamp

BRAND: ZHY

ALL DIMENSIONS: mm

MARKER	PLACES	BEFORE	REVISER	REVISION DATE

NOTIONS:

NO.	PARTS	MATERIAL	QUANTITY	REMARKS
1	INNER RING	GCr15	1	
2	OUTER RING	GCr15	1	
3	BALLS	GCr15	9-ø2.381	
4	RETAINER	SPCC	1	

LOAD RATING STATIC: COr: 714 N

LOAD RATING DYNAMIC: Cr: 1600 N

RADIAL PLAY: C0: 0.002-0.013

TOLERANCES: ABEC-1

CUSTOMER SIZE:

SIZE: 688

庄宏亿
2024-7-5
陈晶晶

庄宏亿
2024-7-5
陈丹央

庄宏亿
2024-7-5
周宝君

DRAWING NO. : QAJ/TR24302

draw

check

approved

DATE:

Jul.5,2024

ZHY NINGBO CHUANG HON YI BEARING CO.,LTD.