

DRAWING

CUSTOMER :

accept stamp

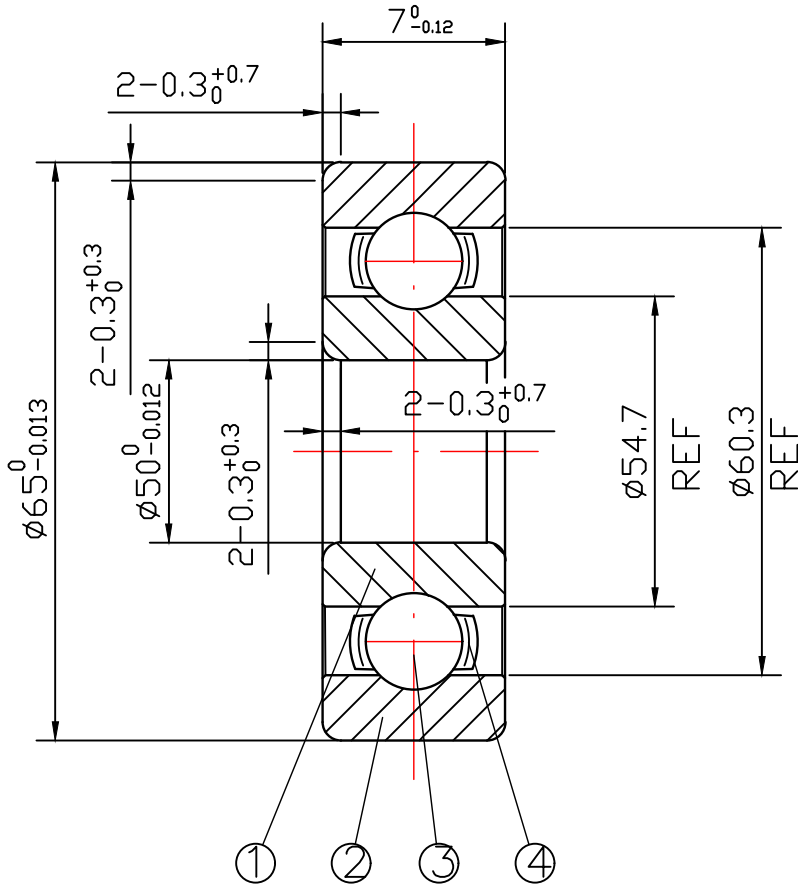

issue stamp

BRAND: ZHY

ALL DIMENSIONS: mm

NOTIONS:

MARKER	PLACES	BEFORE	REVISER	REVISION DATE

NO.	PARTS	MATERIAL	QUANTITY	REMARKS
1	INNER RING	GCr15	1	
2	OUTER RING	GCr15	1	
3	BALLS	GCr15	24- $\phi 3.969$	
4	RETAINER	SPCC	1	

LOAD RATING STATIC: COr: 6080 N

LOAD RATING DYNAMIC: Cr: 6600 N

RADIAL PLAY: C0: 0.006-0.023

TOLERANCES: ABEC-1

CUSTOMER SIZE:

SIZE: 6810

庄宏亿  
2024-7-5  
陈晶晶

庄宏亿  
2024-7-5  
陈丹央

庄宏亿  
2024-7-5  
周宝君

DRAWING NO. : QAJ/TR24319

draw

check

approved

DATE:

Jul.5,2024

**ZHY** NINGBO CHUANG HON YI BEARING CO.,LTD.