

DRAWING

CUSTOMER :

accept stamp

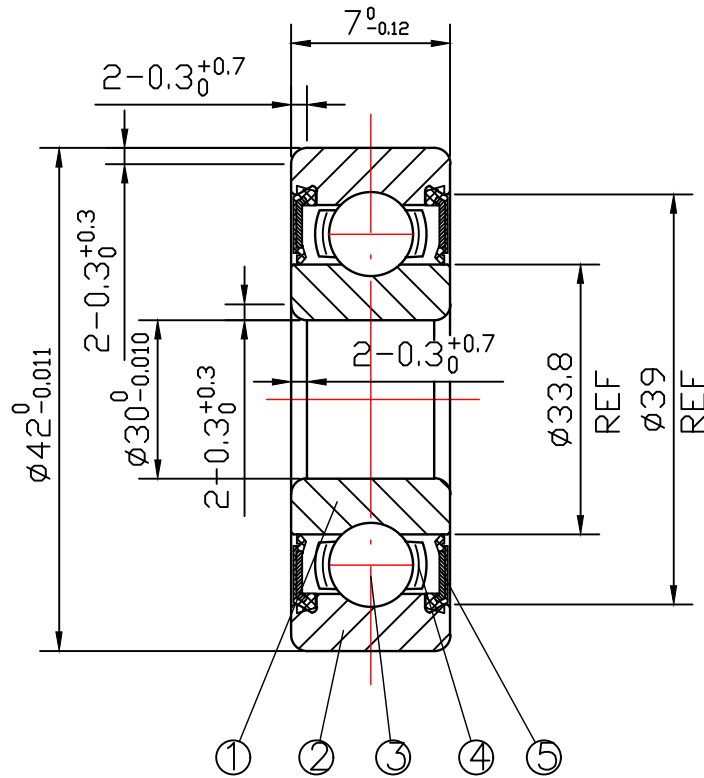

issue stamp

BRAND: ZHY

ALL DIMENSIONS: mm

NOTIONS:

MARKER	PLACES	BEFORE	REVISER	REVISION DATE

NO.	PARTS	MATERIAL	QUANTITY	REMARKS
1	INNER RING	GCr15	1	
2	OUTER RING	GCr15	1	
3	BALLS	GCr15	19- $\phi 3.175$	
4	RETAINER	SPCC	1	
5	SEAL	NBR	2	

LOAD RATING STATIC: COr: 3160 N

LOAD RATING DYNAMIC: Cr: 4020 N

RADIAL PLAY:

C0: 0.005-0.020

TOLERANCES: ABEC-1

CUSTOMER SIZE:

SIZE:

6806-2RS

庄宏亿
2024-5-17
陈晶晶

庄宏亿
2024-5-17
陈丹央

庄宏亿
2024-5-17
周宝君

DRAWING NO. : QAJ/TR24119

draw

check

approved

DATE:

May.17,2024

ZHY NINGBO CHUANG HON YI BEARING CO.,LTD.