

DRAWING

CUSTOMER :

accept stamp

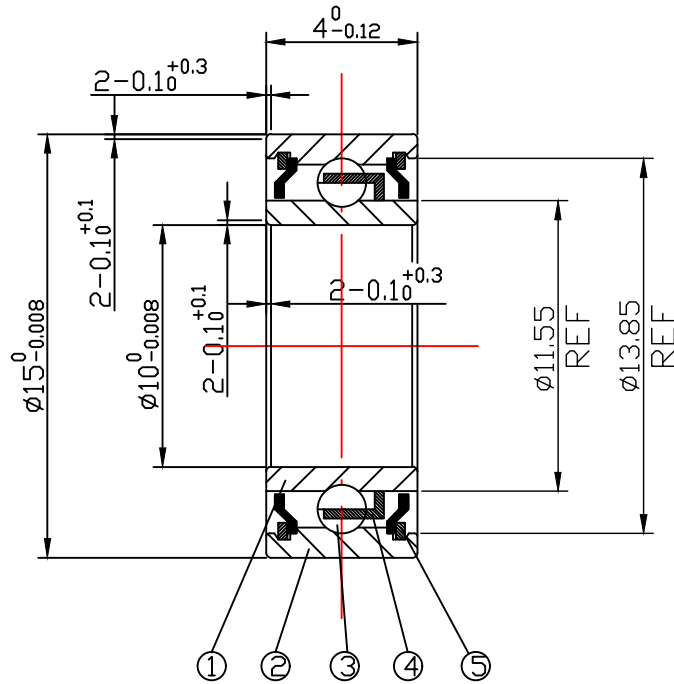

issue stamp

BRAND: ZHY

ALL DIMENSIONS: mm

NOTIONS:

MARKER	PLACES	BEFORE	REVISER	REVISION DATE

NO.	PARTS	MATERIAL	QUANTITY	REMARKS
1	INNER RING	GCr15	1	
2	OUTER RING	GCr15	1	
3	BALLS	GCr15	11- ϕ 1.300	
4	RETAINER	1Cr18Ni9	1	
5	SHIELD	1Cr18Ni9	2	

LOAD RATING STATIC: COr: 305 N

LOAD RATING DYNAMIC: Cr: 572 N

RADIAL PLAY:
C0: 0.002-0.013

TOLERANCES: ABEC-1

CUSTOMER SIZE:

SIZE:
6700ZZ

DRAWING NO. : QAJ/TR23261

draw

check

approved

DATE: Nov.13,2023

ZHY NINGBO CHUANG HON YI BEARING CO.,LTD.