

DRAWING

CUSTOMER :

accept stamp

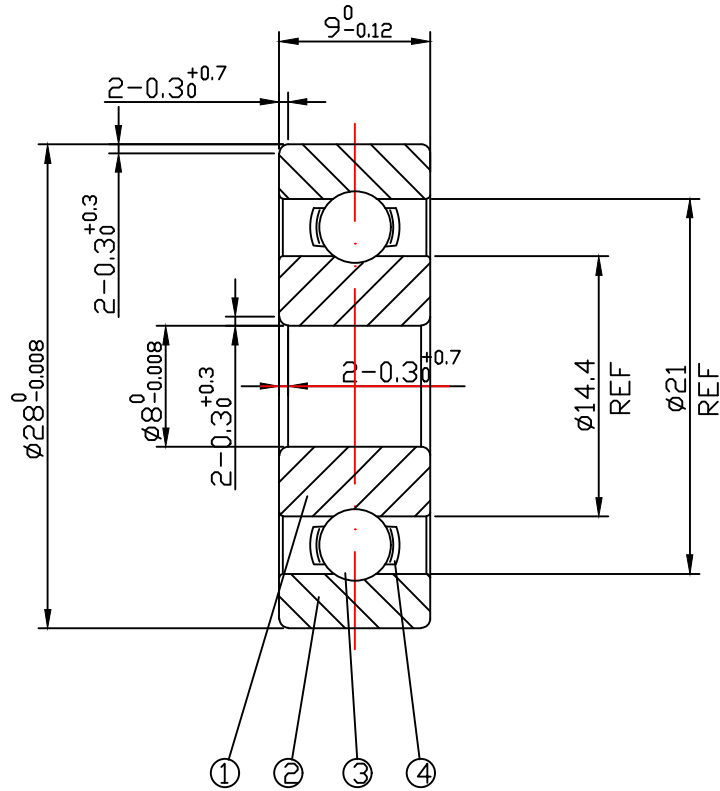

issue stamp

BRAND: ZHY

ALL DIMENSIONS: mm

NOTIONS:

MARKER	PLACES	BEFORE	REVISER	REVISION DATE

NO.	PARTS	MATERIAL	QUANTITY	REMARKS
1	INNER RING	GCr15	1	
2	OUTER RING	GCr15	1	
3	BALLS	GCr15	7- $\phi 4.763$	
4	RETAINER	SPCC	1	

LOAD RATING STATIC: COr: 1950 N

LOAD RATING DYNAMIC: Cr: 4550 N

RADIAL PLAY:

C0: 0.002-0.013

TOLERANCES: ABEC-1

CUSTOMER SIZE:

SIZE:

638

DRAWING NO. : QAJ/TR24284

庄宏亿
2024-7-4
陈晶晶

庄宏亿
2024-7-4
陈丹央

庄宏亿
2024-7-4
周宝君

draw

check

approved

DATE:

Jul.4,2024

ZHY NINGBO CHUANG HON YI BEARING CO.,LTD.