

DRAWING

CUSTOMER :

accept stamp

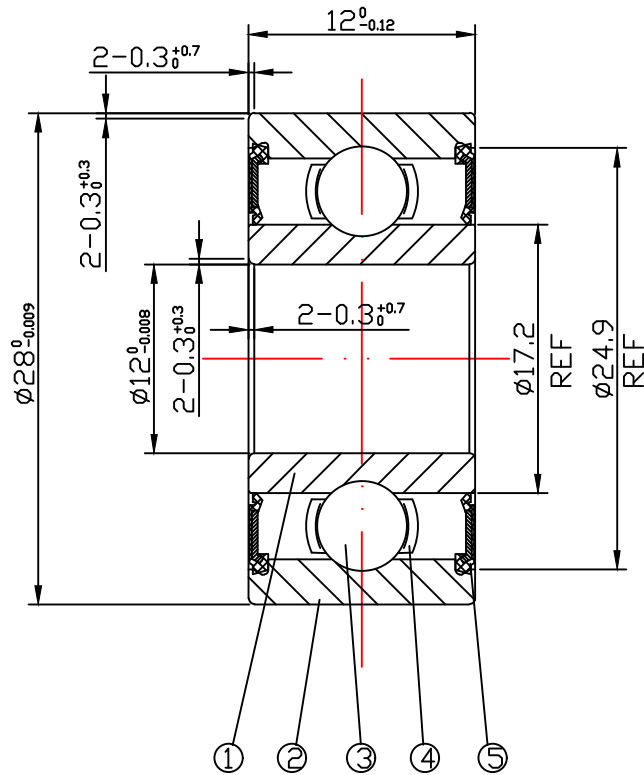

issue stamp

BRAND: ZHY

ALL DIMENSIONS: mm

NOTIONS:

MARKER	PLACES	BEFORE	REVISER	REVISION DATE

NO.	PARTS	MATERIAL	QUANTITY	REMARKS
1	INNER RING	GCr15	1	
2	OUTER RING	GCr15	1	
3	BALLS	GCr15	8- ϕ 4.763	
4	RETAINER	SPCC	1	
5	SEAL	NBR	2	

LOAD RATING STATIC: COr: 2390 N

LOAD RATING DYNAMIC: Cr: 5120 N

RADIAL PLAY:
C0: 0.003-0.018

TOLERANCES: ABEC-1

CUSTOMER SIZE:

SIZE:
63001-2RS

DRAWING NO. : QAJ/TR24174

庄宏亿
2024-5-20
陈晶晶

庄宏亿
2024-5-20
陈丹央

庄宏亿
2024-5-20
周宝君

draw

check

approved

DATE: May.20,2024

ZHY NINGBO CHUANG HON YI BEARING CO.,LTD.