

DRAWING

CUSTOMER :

accept stamp

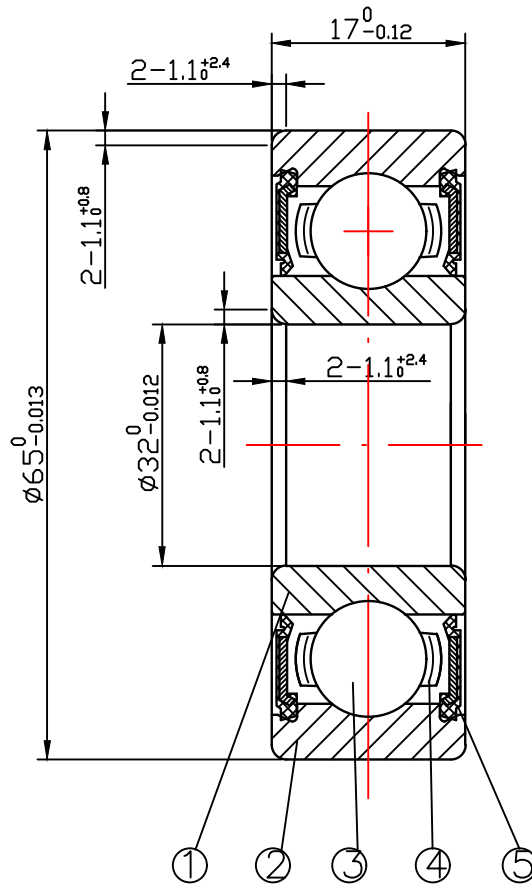

issue stamp

BRAND: ZHY

ALL DIMENSIONS: mm

NOTIONS:

MARKER	PLACES	BEFORE	REVISER	REVISION DATE

NO.	PARTS	MATERIAL	QUANTITY	REMARKS
1	INNER RING	GCr15	1	
2	OUTER RING	GCr15	1	
3	BALLS	GCr15	8- $\phi 10.000$	
4	RETAINER	SPCC	1	
5	SEAL	NBR	2	

LOAD RATING STATIC: COr: 10960 N

LOAD RATING DYNAMIC: Cr: 19620 N

RADIAL PLAY:

C0: 0.006-0.020

TOLERANCES: ABEC-1

CUSTOMER SIZE:

SIZE:

62/32-2RS

DRAWING NO. : QAJ/TR24053

庄宏亿
2024-4-26
陈晶晶

庄宏亿
2024-4-26
陈丹央

庄宏亿
2024-4-26
周宝君

draw

check

approved

DATE:

Apr.26,2024

ZHY NINGBO CHUANG HON YI BEARING CO.,LTD.