

DRAWING

CUSTOMER :

accept stamp

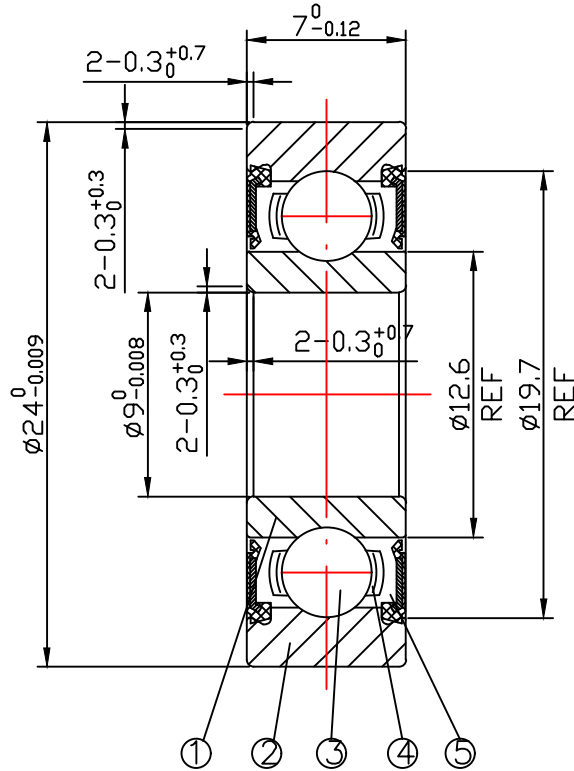

issue stamp

BRAND: ZHY

ALL DIMENSIONS: mm

MARKER	PLACES	BEFORE	REVISER	REVISION DATE

NOTIONS:

NO.	PARTS	MATERIAL	QUANTITY	REMARKS
1	INNER RING	GCr15	1	
2	OUTER RING	GCr15	1	
3	BALLS	GCr15	7- $\phi 3.969$	
4	RETAINER	SPCC	1	
5	SEAL	NBR	2	

LOAD RATING STATIC: COr: 1410 N

LOAD RATING DYNAMIC: Cr: 3330 N

RADIAL PLAY: C0: 0.002-0.013

TOLERANCES: ABEC-1

CUSTOMER SIZE:

SIZE: 609-2RS

庄宏亿
2024-4-24
陈晶晶

庄宏亿
2024-4-24
陈丹央

庄宏亿
2024-4-24
周宝君

DRAWING NO. : QAJ/TR24039

draw

check

approved

DATE: Apr.25,2024

ZHY NINGBO CHUANG HON YI BEARING CO.,LTD.