

DRAWING

CUSTOMER :

accept stamp

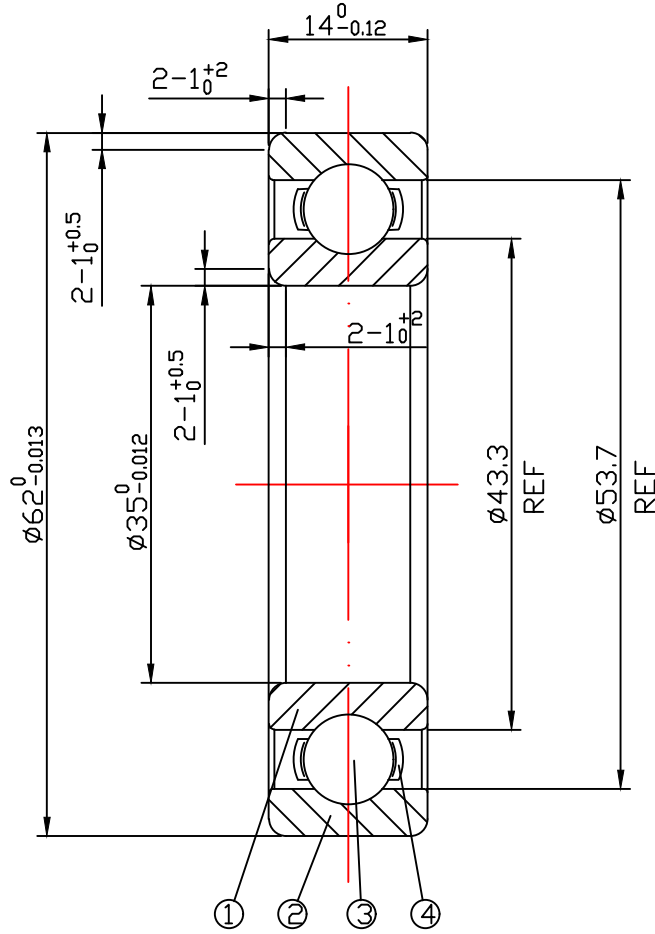

issue stamp

BRAND: ZHY

ALL DIMENSIONS: mm

MARKER	PLACES	BEFORE	REVISER	REVISION DATE

NOTIONS:

NO.	PARTS	MATERIAL	QUANTITY	REMARKS
1	INNER RING	GCr15	1	
2	OUTER RING	GCr15	1	
3	BALLS	GCr15	11-ø7.938	
4	RETAINER	SPCC	1	

LOAD RATING STATIC: COr: 10320 N

LOAD RATING DYNAMIC: Cr: 15950 N

RADIAL PLAY: C0: 0.006-0.020

TOLERANCES: ABEC-1

CUSTOMER SIZE:

SIZE: 6007

庄宏亿
2024-6-29
陈晶晶

庄宏亿
2024-6-29
陈丹央

庄宏亿
2024-6-29
周宝君

DRAWING NO. : QAJ/TR24247

draw

check

approved

DATE: Jun.29,2024

ZHY NINGBO CHUANG HON YI BEARING CO.,LTD.