

DRAWING

CUSTOMER :

accept stamp

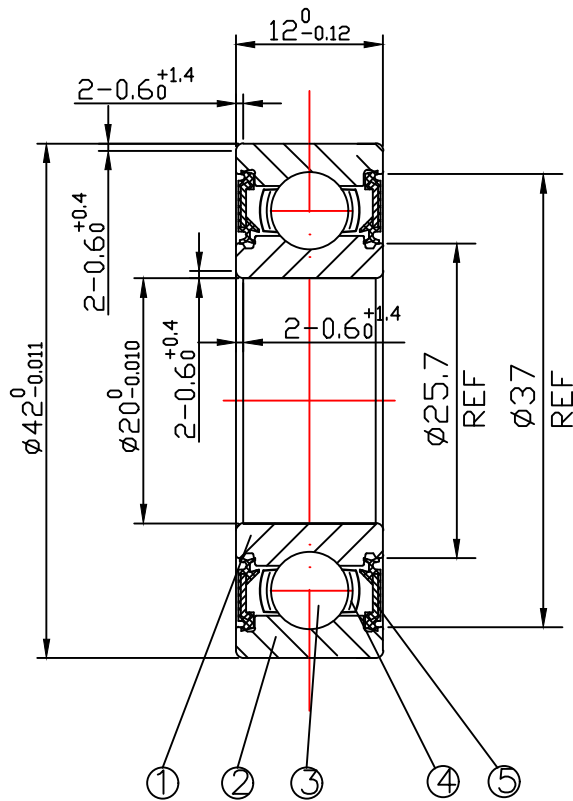

issue stamp

BRAND: ZHY

ALL DIMENSIONS: mm

NOTIONS:

MARKER	PLACES	BEFORE	REVISER	REVISION DATE

NO.	PARTS	MATERIAL	QUANTITY	REMARKS
1	INNER RING	GCr15	1	
2	OUTER RING	GCr15	1	
3	BALLS	GCr15	9- $\phi 6.35$	
4	RETAINER	SPCC	1	
5	SEAL	NBR	2	

LOAD RATING STATIC: COr: 5080 N

LOAD RATING DYNAMIC: Cr: 9380 N

RADIAL PLAY:

C0: 0.005-0.020

TOLERANCES: ABEC-1

CUSTOMER SIZE:

SIZE:

6004-2RS

庄宏亿
2024-4-25
陈晶晶

庄宏亿
2024-4-25
陈丹央

庄宏亿
2024-4-25
周宝君

DRAWING NO. : QAJ/TR24044

draw

check

approved

DATE:

Apr.24,2024

ZHY NINGBO CHUANG HON YI BEARING CO.,LTD.