

DRAWING

CUSTOMER :

accept stamp

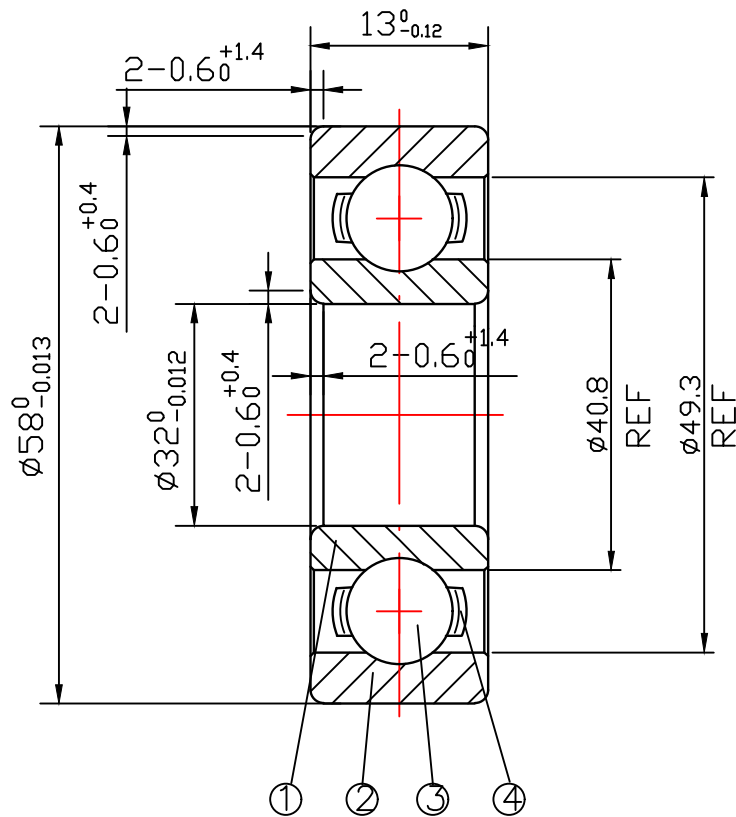

issue stamp

BRAND: ZHY

ALL DIMENSIONS: mm

NOTIONS:

MARKER	PLACES	BEFORE	REVISER	REVISION DATE

NO.	PARTS	MATERIAL	QUANTITY	REMARKS
1	INNER RING	GCr15	1	
2	OUTER RING	GCr15	1	
3	BALLS	GCr15	11- $\phi 6.747$	
4	RETAINER	SPCC	1	

LOAD RATING STATIC: COr: 7611N

LOAD RATING DYNAMIC: Cr: 11848N

RADIAL PLAY: C0: 0.006-0.020

TOLERANCES: ABEC-1

CUSTOMER SIZE:

SIZE:

60/32

DRAWING NO. : QAJ/TR23255

庄宏亿  
2023-7-3  
陈晶晶

庄宏亿  
2023-7-3  
陈丹央

庄宏亿  
2023-7-3  
周宝君

draw

check

approved

DATE:

Jul.3,2023

ZHY NINGBO CHUANG HON YI BEARING CO.,LTD.