

DRAWING

CUSTOMER :

accept stamp

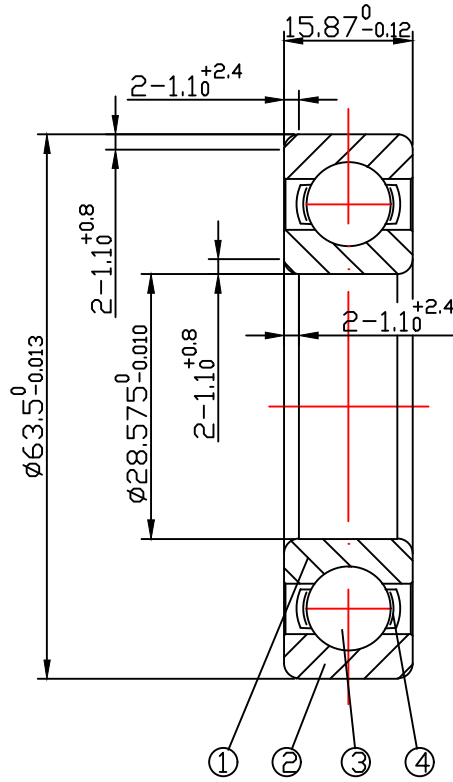

issue stamp

BRAND: ZHY

ALL DIMENSIONS: mm

MARKER	PLACES	BEFORE	REVISER	REVISION DATE

NOTIONS:

NO.	PARTS	MATERIAL	QUANTITY	REMARKS
1	INNER RING	GCr15	1	
2	OUTER RING	GCr15	1	
3	BALLS	GCr15	9- $\phi 9.525$	
4	RETAINER	SPCC	1	

LOAD RATING STATIC: COr: 11430 N

LOAD RATING DYNAMIC: Cr: 19470 N

RADIAL PLAY: C0: 0.005-0.020

TOLERANCES: ABEC-1

CUSTOMER SIZE:

SIZE: 1652

庄宏亿
2024-7-9
陈晶晶

庄宏亿
2024-7-9
陈丹央

庄宏亿
2024-7-9
周宝君

DRAWING NO. : QAJ/TR24392

draw

check

approved

DATE:

Jul.9,2024

ZHY NINGBO CHUANG HON YI BEARING CO.,LTD.