

DRAWING

CUSTOMER :

accept stamp

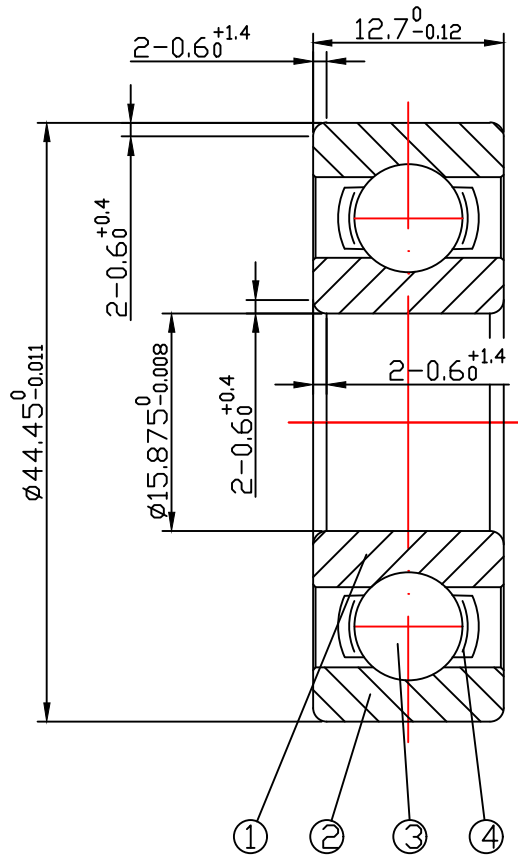

issue stamp

BRAND: ZHY

ALL DIMENSIONS: mm

MARKER	PLACES	BEFORE	REVISER	REVISION DATE

NOTIONS:

NO.	PARTS	MATERIAL	QUANTITY	REMARKS
1	INNER RING	GCr15	1	
2	OUTER RING	GCr15	1	
3	BALLS	GCr15	8- $\phi 6.747$	
4	RETAINER	SPCC	1	

LOAD RATING STATIC: COr: 4800 N

LOAD RATING DYNAMIC: Cr: 9580 N

RADIAL PLAY:

C0: 0.003-0.018

TOLERANCES: ABEC-1

CUSTOMER SIZE:

SIZE:

1633

庄宏亿  
2024-7-9  
陈晶晶

庄宏亿  
2024-7-9  
陈丹央

庄宏亿  
2024-7-9  
周宝君

DRAWING NO. : QAJ/TR24387

draw

check

approved

DATE:

Jul.9,2024

ZHY NINGBO CHUANG HON YI BEARING CO.,LTD.