

DRAWING

CUSTOMER :

accept stamp

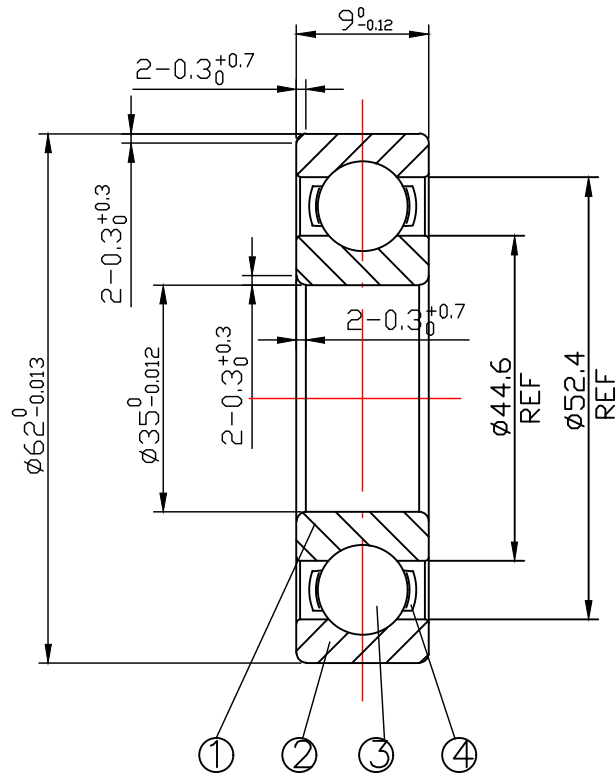

issue stamp

BRAND: ZHY

ALL DIMENSIONS: mm

NOTIONS:

MARKER	PLACES	BEFORE	REVISER	REVISION DATE

NO.	PARTS	MATERIAL	QUANTITY	REMARKS
1	INNER RING	GCr15	1	
2	OUTER RING	GCr15	1	
3	BALLS	GCr15	14- $\phi 5.953$	
4	RETAINER	SPCC	1	

LOAD RATING STATIC: COr: 7880N

LOAD RATING DYNAMIC: Cr: 10770 N

RADIAL PLAY:
C0: 0.006-0.020

TOLERANCES: ABEC-1

CUSTOMER SIZE:

SIZE:
16007

DRAWING NO. : QAJ/TR23238

庄宏亿
2023-11-13
陈晶晶

庄宏亿
2023-11-13
陈丹央

庄宏亿
2023-11-13
周宝君

draw

check

approved

DATE: Nov.13,2023

ZHY NINGBO CHUANG HON YI BEARING CO.,LTD.